

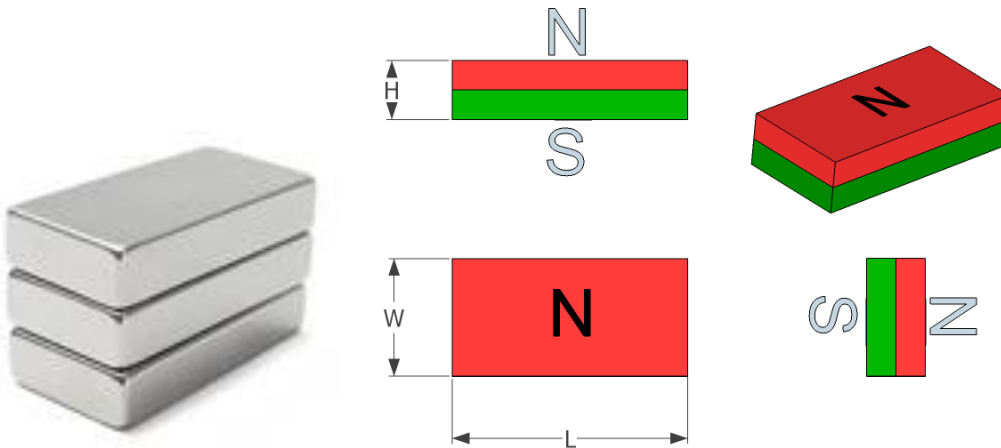

+27(0) 21 591 8019
 info@allmag.co.za
 Unit 7
 Klein Oostersee Centre
 53 Friesland St
 Oostersee
 Cape Town
 7500

RARE EARTH MAGNETS (NEODYMIUM MAGNETS)

Block Magnets Neodymium:



LENGHT / (mm)	WIDHT (mm)	HEIGHT (mm)	GRADE	ORIENTATION
8.6	8.6	3	N38	3↑
15	15	40	N35	40↑
20	10	5	N35	5↑
25	7.6	2	N35	2↑
25.4 (1")	12.7 (½")	6.35 (¼")	N48	6.35 (¼") ↑
50	25	15	N35	15↑
50	20	8	N35	8↑
50	50	15	N42	15↑
50.8 (2")	25.4 (1")	12.7 (½")	N48	12.7 (½") ↑

Powerful Neodymium Disc / Cylinder Shaped Magnets:

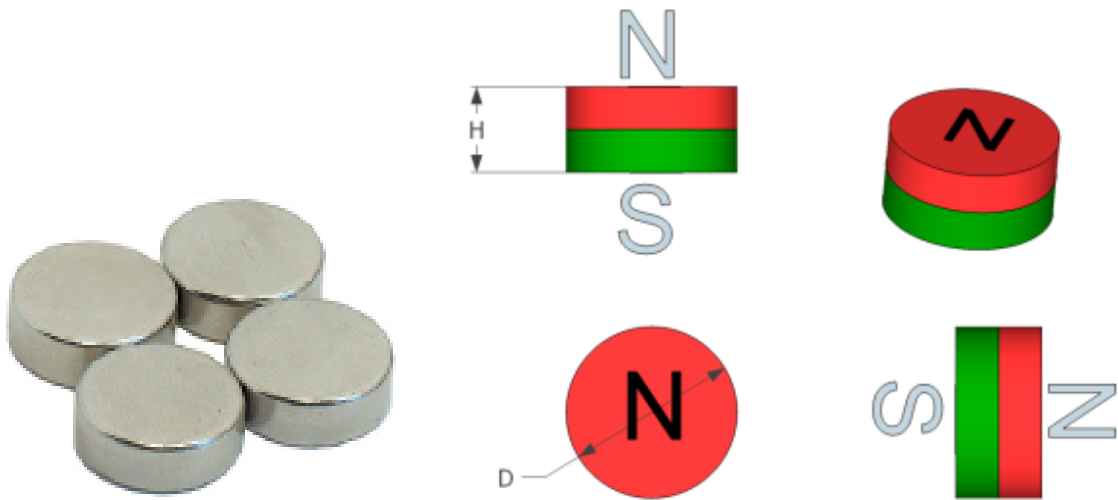

DIAMETER Ø (mm)	HEIGHT (mm)	GRADE	ORIENTATION
3	1	N35	1↑
5	1.5	N35	1.5↑
5	3	N35	3↑
5	8	N35	8↑
6	3	N35	3↑
6	25	N35	25↑
8	5	N35	5↑
9	3	N35	3↑
10	1.5	N35	1.5↑
10	5	N35	5↑
12	7	N35	7↑
15	10	N35	10↑
18	6	N35	6↑
20	3	N35	3↑
22	10	N42	10↑
22	20	N42	20↑
30	25	N35	25↑
48	22	N35	22↑

Powerful Neodymium Ring Shaped Magnets:

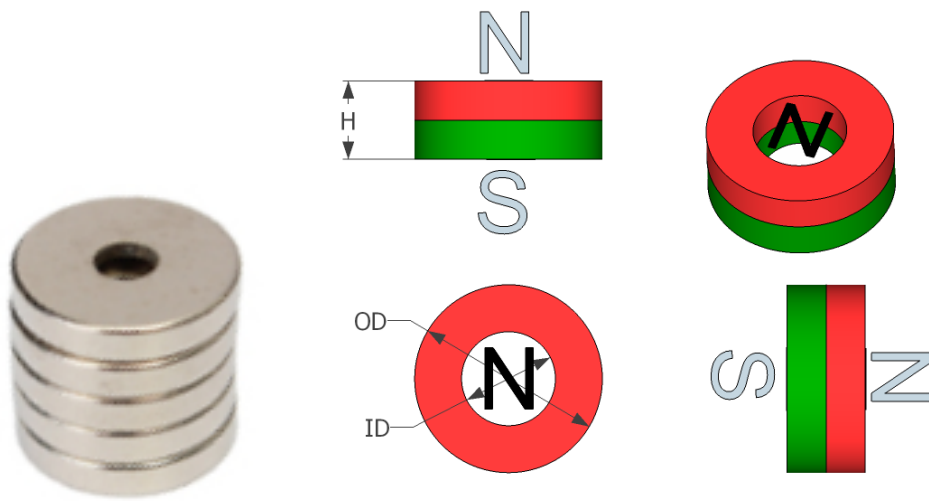

OUTSIDE DIAMETER (mm)	INSIDE DIAMETER (mm)	HEIGHT (mm)	GRADE	ORIENTATION
8	3.5	5	N35	5↑
15	5	4	N35	4↑
25	7	6	N35	6↑

FERRITE MAGNETS (CERAMICS)

Block Magnets Ferrite:

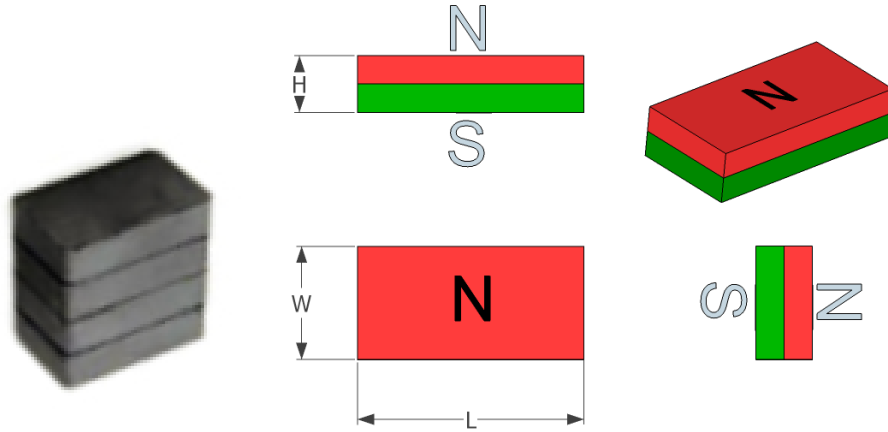

LENGTH (mm)	WIDHT (mm)	HEIGHT (mm)	ORIENTATION
8	8	25	25↑
20	10	5	5↑
45	20	10	10↑
50	19	5	5↑
60	10	5	5↑
75	50	20	20↑
150	100	25	25↑

Powerful Ferrite Disc / Cylinder Shaped Magnets:

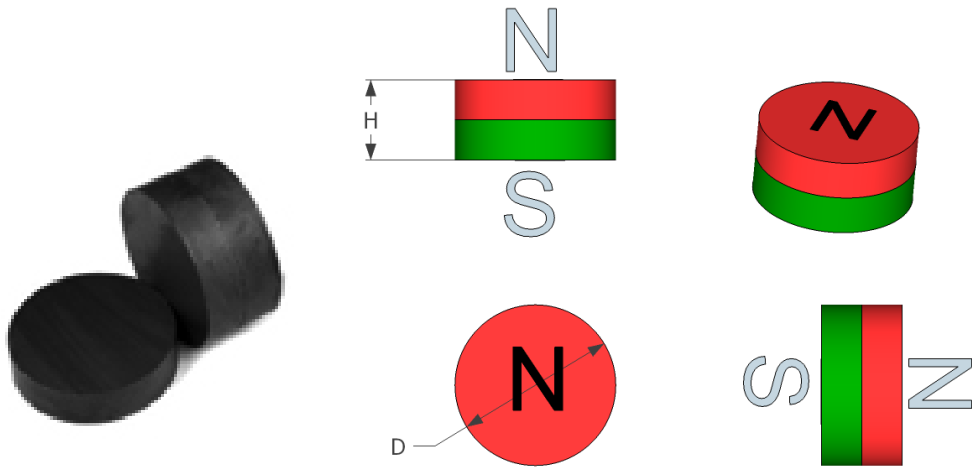

DIAMETER \varnothing (mm)	HEIGHT (mm)	ORIENTATION
6	2	2 \uparrow
12	5	5 \uparrow
18	5	5 \uparrow
32	12	12 \uparrow
45	7	7 \uparrow

Powerful Ferrite Ring Shaped Magnets:

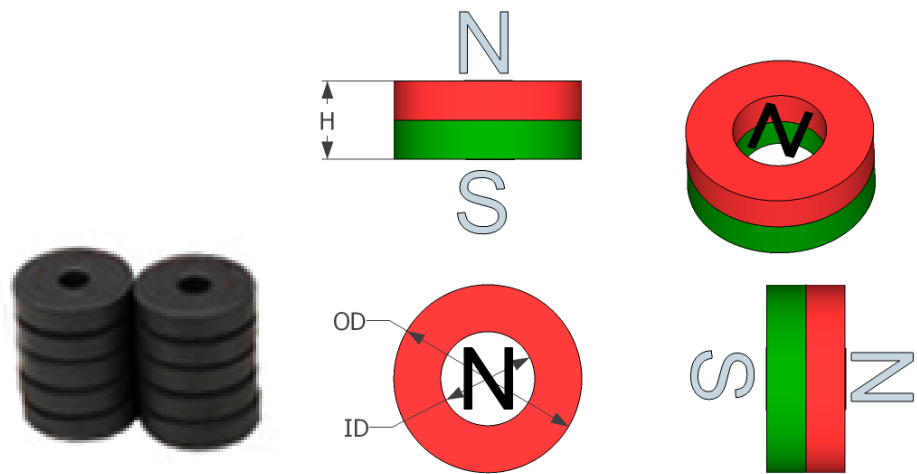

OUTSIDE DIAMETER (mm)	INSIDE DIAMETER (mm)	HEIGHT (mm)	ORIENTATION
20	8	5	5↑
36	18	6	6↑
45	22	8	8↑
60	32	10	10↑
80	40	10	10↑

POT MAGNETS / BASE MAGNETS

Rare Earth (NdFeB) - Pot Magnets:

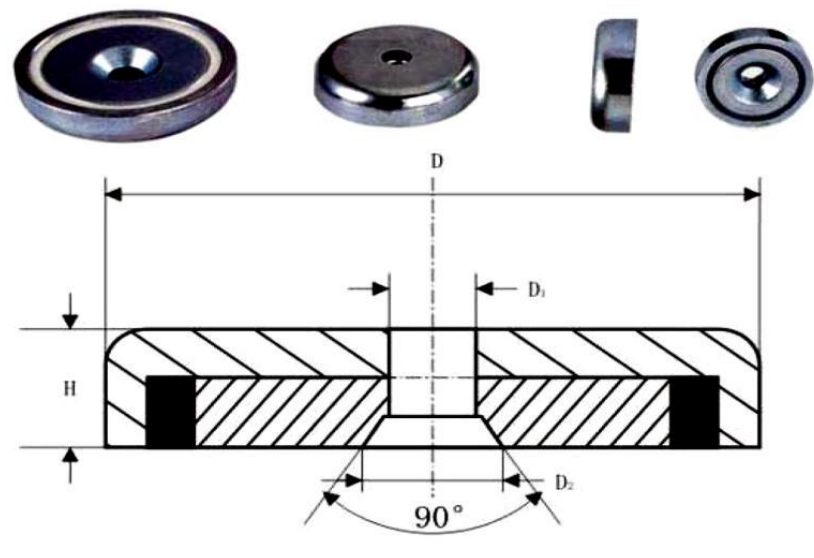

MODEL NO.	ØD	ØD1	ØD2	H	HOLDIN G FORCE (KG)	WEIGHT	ORIENT ATION
A16	16	3.5	6.5	5	5	7	5↑
A20	20	4.5	8.5	7	6	13	7↑
A32	32	5.5	10.4	8	25	39	8↑
A48	48	8.5	16	11.5	68	120	11.5↑
A75	75	10.5	19	18	162	488	18↑

Ferrite/Base (BaFe) - Pot Magnets:

POT SIZE	OUTSIDE DIAMETER (OD)	INSIDE DIAMETER (ID)	HEIGHT (MM)	ORIENTATION
RB 30	30	6	3	3↑
RB 50	50	7	5	5↑
RB 80	80	10	7	7↑
RUBBER COVER FOR RB 80				

MAGNETIC SHEET & TAPE

Magnetic Sheet:



Sheet 0,5mm thick x 457 x 620mm PSA

(PSA = pressure sensitive adhesive)

Magnetic Tape:



Tape 19mm x 1,5mm Thick PSA

Tape 12mm x 1,5mm Thick PSA

(PSA = pressure sensitive adhesive)